



NIPRESS

P6

programming device

Installation and programming manual

2nd edition

TABLE OF CONTENTS

1. INTRODUCTION	3
1.1 APPLICATION.....	3
1.2 ACCESSORIES.....	3
2. INSTALLATION AND WIRING	3
2.1 GENERAL NOTES	3
2.2 STEPS OF INSTALLATION	3
2.3 WIRING	4
2.4 DIMENSIONS	5
3. PROGRAMMING	6
3.1 OPERATING AND DISPLAY MODULE	6
3.2 CONFIGURATION.....	6
3.3 STRUCTURE OF THE MENU SYSTEM	7
3.4 PARAMETERS DESCRIPTION AND PROGRAMMING	8
4. MAINTENANCE AND REPAIR	12
5. WARRANTY	12



1. INTRODUCTION

1.1 APPLICATION

The programming device P6 was developed especially for the configuration of the **NIPRESS DK-100** and **DK-200** pressure switches on site without a laptop. The programming device has to be connected between supply and the pressure switch. Programming device P6 has a user friendly, closed menu system which can be configured via two miniature push buttons on the front. All settings are permanently stored in an EEPROM and can be transferred to other pressure switches. Additional existing reference pressure in the pressure switch can be "taught" as switch-on or switch-off points.

1.2 ACCESSORIES

Please check the contents of packaging. Ensure that all parts listed are contained therein:

- programming device P6 with integrated cable
- operating manual

2. INSTALLATION AND WIRING

2.1 GENERAL NOTES

Please note that this device is a sensitive programming kit. Handle the device carefully so that there is no damage to the plastic surface and housing parts. The display is equipped with a rotational limiter. Please do not try with force to turn the display further than it should go.

2.2 STEPS OF INSTALLATION

Remove the programming device carefully from the packaging.

- Separate the fitted pressure switch from the supply
- Plug the supply on the connector on the top of the programming device and connect the female connector M12 x 1 from the programming device with the pressure switch
- If everything was done correctly, the LED-display starts showing the program (e.g P002)
- Now you can start programming the pressure switch.

Please note: The programming device needs an external power supply, so ensure that the power is not switched off.

2.3 WIRING

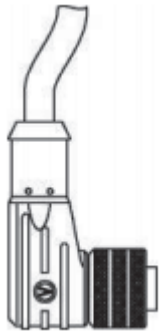
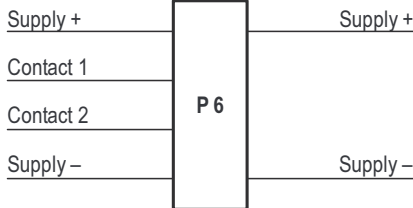
On the top of the device	On the end of the cable	Wiring diagram		
				
M 12 x 1 (5-pin) male connector	M 12 x 1 (5-pin) female connector	female connector	male connector	
Electrical connection	Male plug on the programming device		Female plug on end of cable	
	for DK-100: M 8 x 1 (4-pin) plastic	for DK-200: M 12 x 1 (5-pin) plastic	for DK-100: M 8 x 1 (4-pin) plastic	for DK-200: M 12 x 1 (5-pin) plastic
Supply +	1	1	1 ¹	1 ¹
Supply -	3	3	3	3
Contact 1	-	-	4 ¹	4 ¹
Contact 2	-	-	2 ^{1,2}	5 ¹
Analogue signal	-	-	2 ²	2

¹ Is used for data communication between P 6 and pressure switch

² The pressure switch optionally can be equipped with an analogue output or a second contact. This output/contact is Pin 2.

2.4 DIMENSIONS

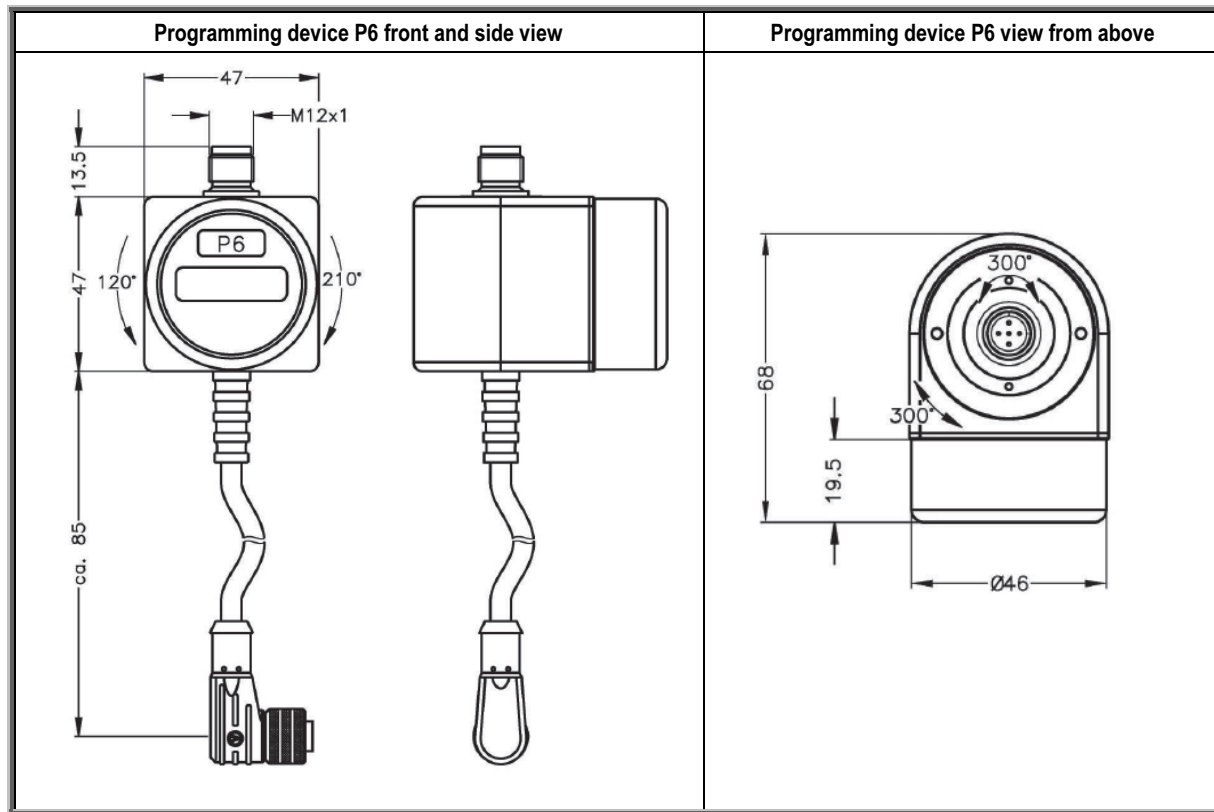

3. PROGRAMMING

3.1 OPERATING AND DISPLAY MODULE

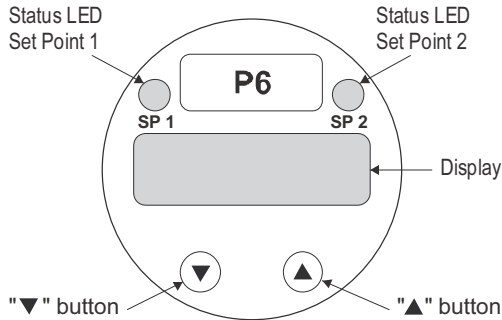

The device has a green LED for displaying the active contact of set point 1 and a yellow LED for displaying the active contact of set point 2. The LEDs will light up when the respective set point has been reached and the contact is active. The LED for set point 1 also shows that there is a communication between pressure switch and programming device.

The display of the measured value as well as the configuration of the individual parameters occurs through a menu via a 4-digit seven-segment display. The individual functions can be set with the help of two miniature push buttons located in the front:

- "▲" button: with this button, you move forward in the menu system or increase the displayed value
- "▼" button: with this button, you move back in the menu system or decrease the displayed value
- both buttons simultaneously: if both buttons are pushed simultaneously, the device changes between display and configuration mode; you can also confirm the menu items and set values with them.

You can increase the counting speed by keeping the respective button ("▲" or "▼"), if the button is pressed for more than 5 seconds.





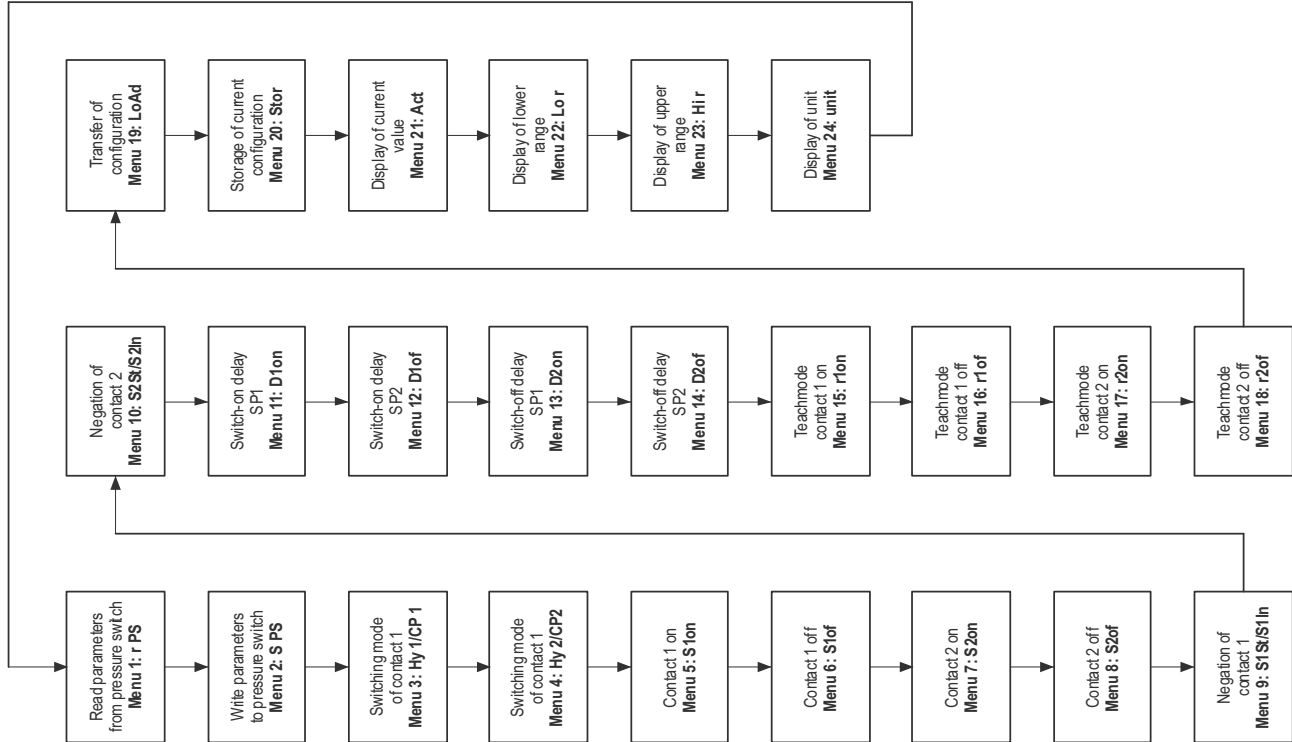

3.2 CONFIGURATION







All settings are permanently stored in an EEPROM and therefore available again even after disconnecting from the supply voltage. The menu system and the menu items have been designed as simply as possible. Below, each individual menu item is described in detail allowing a straightforward and quick configuration of your device.







3.3 STRUCTURE OF THE MENU SYSTEM



3.4 PARAMETERS DESCRIPTION AND PROGRAMMING

Menu 1 – Read All	
	Via the menu „Read All“ all parameters are transferred from the pressure switch into the programming device. This function must be carried out after connection power supply. After switching on the power supply, it is only possible to execute this function and the function „Load“. To execute the „Read All“-function it is required to press both buttons simultaneously. The display of the programming device will be out of function until all parameters are transferred from the pressure switch into programming device. During the data transfer the green LED indicates the data stream from the pressure switch.
Menu 2 – Store All	
	Via the menu „Store All“ all parameters are transferred from the programming device into the pressure switch. To execute the „Store All“ function it is required to press both buttons simultaneously. During the data transfer the display will be out of function and the green LED indicates the data stream from the pressure switch.
Menu 3 – Mode SP 1	
	Via the menu “Mode SP 1” it is possible to select the switching mode of set point 1 of the pressure switch. It is possible to select between Hysteresis mode (HY 1), Window mode (CP 1), and off (off1). By pressing both buttons simultaneously setup mode is entered. To select the desired function, it is necessary to press “▲” or “▼” buttons until the desired function is displayed. To finish the configuration and to store the selection it is required to press both buttons simultaneously.
Menu 4 – Mode SP 2	
	Via the menu “Mode SP 2” it is possible to select the switching mode of set point 2 of the pressure switch. It is possible to select between Hysteresis mode (HY 2), Window mode (CP 2), and off (off2). By pressing both buttons simultaneously setup mode is entered. To select the desired function, it is necessary to press “▲” or “▼” buttons until the desired function is displayed. To finish the configuration and to store the selection it is required to press both buttons simultaneously.
Menu 5 - Switch-on point / lowest set point SP 1	
	Via the menu “Switch-on point / lowest set point” it is possible to define the switch-on point of the pressure switch (contact 1). Setup mode is entered by pressing both buttons simultaneously. You can set the required value by using the buttons “▲” or “▼”. To complete the setting push the two buttons simultaneously.
Menu 6 - Switch-off point / highest set point SP	
	Via the menu “Switch-off point / highest set point” it is possible to define the switch-off point of the pressure switch (contact 1). Setup mode is entered by pressing both buttons simultaneously. You can set the required value by using the buttons “▲” or “▼”. To complete the setting push the two buttons simultaneously.

Menu 7 - Switch-on point / lowest set point SP 2	
	Via the menu "Switch-on point / lowest set point" it is possible to define the switch-on point of the pressure switch (contact 2). Setup mode is entered by pressing both buttons simultaneously. You can set the required value by using the buttons "▲" or "▼". To complete the setting push the two buttons simultaneously.
Menu 8 - Switch-off point / highest set point SP 2	
	Via the menu "Switch-off point / highest set point" it is possible to define the switch-off point of the pressure switch (contact 2). Setup mode is entered by pressing both buttons simultaneously. You can set the required value by using the buttons "▲" or "▼". To complete the setting push the two buttons simultaneously.
Menu 9 - Set point negation SP 1	
	Via the menu "Set point negation" it is possible to invert the output signal of set point 1. Setup mode is entered by pressing both buttons simultaneously. To select between standard (not inverted) signal (S1St) and inverted signal (S1In) it is necessary to press one of both buttons until the desired function is displayed. To finish the configuration and to store the selection it is required to press both buttons simultaneously.
Menu 10 - Set point negation SP 2	
	Via the menu "Set point negation" it is possible to invert the output signal of set point 2. Setup mode is entered by pressing both buttons simultaneously. To select between standard (not inverted) signal (S2St) and inverted signal (S2In) it is necessary to press one of both buttons until the desired function is displayed. To finish the configuration and to store the selection it is required to press both buttons simultaneously.
Menu 11 – Switch on delay SP 1	
	Via the menu "Switch-on delay" it is possible to set the delay time of set point 1. Setup mode is entered by pressing both buttons simultaneously. You can set the required value by using the buttons "▲" or "▼". The delay time can be set between 0.01 and 90 seconds. To complete the setting push the two buttons simultaneously.
Menu 12 – Switch off delay SP 1	
	Via the menu "Switch-off delay" it is possible to set the delay time of set point 1. Setup mode is entered by pressing both buttons simultaneously. You can set the required value by using the buttons "▲" or "▼". The delay time can be set between 0.01 and 90 seconds. To complete the setting push the two buttons simultaneously.
Menu 13 – Switch on delay SP 2	
	Via the menu "Switch-on delay" it is possible to set the delay time of set point 2. Setup mode is entered by pressing both buttons simultaneously. You can set the required value by using the buttons "▲" or "▼". The delay time can be set between 0.01 and 90 seconds. To complete the setting push the two buttons simultaneously.

Menu 14 – Switch off delay SP 2	
	Via the menu “Switch-off delay” it is possible to set the delay time of set point 2. Setup mode is entered by pressing both buttons simultaneously. You can set the required value by using the buttons “▲ “ or “▼ “.The delay time can be set between 0.01 and 90 seconds. To complete the setting push the two buttons simultaneously.
Menu 15 – Teach – Switch-on point SP 1	
	Via the menu “Teach switch-on point” the currently existing reference pressure in the pressure switch can be “taught” as switch-on point 1. For the teaching-operation you have to push both buttons simultaneously. Then “ref” will appear in the display and you have to connect the reference pressure on the pressure port of the switch. Is the reference value correct, accept it by pushing the two buttons simultaneously and the value will be stored in the pressure switch.
Menu 16 – Teach – Switch-off point SP 1	
	Via the menu “Teach switch-off point” the currently existing reference pressure in the pressure switch can be “taught” as switch-on point 1. For the teaching-operation you have to push both buttons simultaneously. Then “ref” will appear in the display and you have to connect the reference pressure on the pressure port of the switch. Is the reference value correct, accept it by pushing the two buttons simultaneously and the value will be stored in the pressure switch.
Menu 17 – Teach – Switch-on point SP 2	
	Via the menu “Teach switch-on point” the currently existing reference pressure in the pressure switch can be “taught” as switch-on point 2. For the teaching-operation you have to push both buttons simultaneously. Then “ref” will appear in the display and you have to connect the reference pressure on the pressure port of the switch. Is the reference value correct, accept it by pushing the two buttons simultaneously and the value will be stored in the pressure switch.
Menu 18 – Teach – Switch-off point SP 2	
	Via the menu “Teach switch-off point” the currently existing reference pressure in the pressure switch can be “taught” as switch-on point 2. For the teaching-operation you have to push both buttons simultaneously. Then “ref” will appear in the display and you have to connect the reference pressure on the pressure port of the switch. Is the reference value correct, accept it by pushing the two buttons simultaneously and the value will be stored in the pressure switch.
Menu 19 – Loading of stored configurations	
	Via the menu “Load” it is possible to transfer up to five in P6 stored configurations into the pressure switch. During the transmitting the programming device checks whether the pressure switch matches with the configuration data. This approach shall make sure that the configuration data can be processed by the pressure switch. To start transfer of the desired configuration first both keys must be pressed simultaneously. Afterwards it is necessary to select one of the five configuration memories by pressing one of the keys until the desired memory (Loa1 till Loa5) is displayed. After the selection of the desired memory location the take-over of the data is started by pressing both buttons simultaneously. During the data transfer the display will be out of function and the green LED will indicate the data stream from the pressure switch.

Menu 20 – Storage of current configurations	
Stor	Via the menu “Stor” you can store maximally 5 different configurations in the programming device. To file the data on the desired storage space you have to push both buttons simultaneously to select the required storage space. After activating the storage mode in the display appears “St n” - n stands for the required storage space. To store the configuration, you have to press the buttons simultaneously, again.
Menu 21 – Showing the current pressure value	
Act	When the menu “Act” is active it is possible to display the current pressure value. The current value is displayed for two seconds after both buttons were pressed simultaneously. It is possible to repeat this process after “Act” is on the display again.
Menu 22 – Showing the low limit of the measuring range	
Lo r	When the menu “Lo r” is active it is possible to display the low limit of the measuring range of the pressure switch. The low limit is displayed for two seconds after both buttons were pressed simultaneously. It is possible to repeat this process after “Lo r” is on the display again.
Menu 23 – Showing the high limit of the measuring range	
Hi r	When the menu “Hi r” is active it is possible to display the high limit of the measuring range of the pressure switch. The high limit is displayed for two seconds after both buttons were pressed simultaneously. It is possible to repeat this process after “Hi r” is on the display again.
Menu 24 – Showing the unit	
unit	When the menu “unit” is active it is possible to display the unit of the pressure value with which the pressure switch works. The unit is displayed for two seconds after both buttons were pressed simultaneously. It is possible to repeat this process after “unit” is on the display again.

4. MAINTENANCE AND REPAIR

The instrument does not require regular maintenance. If necessary possible dirt deposited should be cleaned off. All repairs will be carried out at the Manufacturer's premises.

5. WARRANTY

NIVELCO provides warranty of 3 (three) years in compliance with details described in the Warranty Card.



Distribuidora Autorizada: NIVETEC Instrumentação e Controle Ltda
Tel.:(11) 2627-6600 | comercial@nivetec.com.br | www.nivetec.com.br

jbdp612a0600p_02
September 2017